

Operating manual  
**SMA DATA MANAGER M**

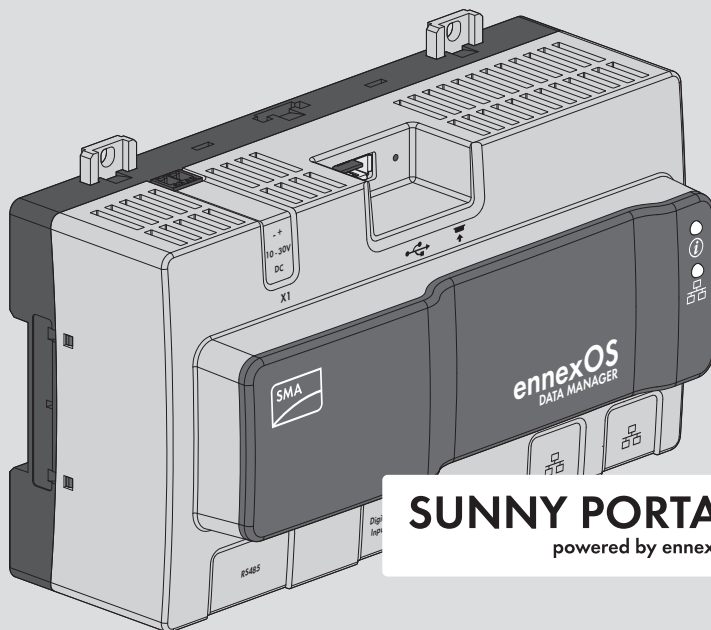

## Legal Provisions

The information contained in these documents is the property of SMA Solar Technology AG. No part of this document may be reproduced, stored in a retrieval system, or transmitted, in any form or by any means, be it electronic, mechanical, photographic, magnetic or otherwise, without the prior written permission of SMA Solar Technology AG. Internal reproduction used solely for the purpose of product evaluation or other proper use is allowed and does not require prior approval.

SMA Solar Technology AG makes no representations or warranties, express or implied, with respect to this documentation or any of the equipment and/or software it may describe, including (with no limitation) any implied warranties of utility, merchantability, or fitness for any particular purpose. All such representations or warranties are expressly disclaimed. Neither SMA Solar Technology AG nor its distributors or dealers shall be liable for any indirect, incidental, or consequential damages under any circumstances.

The exclusion of implied warranties may not apply in all cases under some statutes, and thus the above exclusion may not apply.

Specifications are subject to change without notice. Every attempt has been made to make this document complete, accurate and up-to-date. Readers are cautioned, however, that product improvements and field usage experience may cause SMA Solar Technology AG to make changes to these specifications without advance notice or per contract provisions. SMA Solar Technology AG shall not be responsible for any damages, including indirect, incidental or consequential damages, caused by reliance on the material presented, including, but not limited to, omissions, typographical errors, arithmetical errors or listing errors in the content material.

### SMA Warranty

You can download the current warranty conditions from the Internet at [www.SMA-Solar.com](http://www.SMA-Solar.com).

### Software licenses

The licenses for the installed software modules (open source) can be found in the user interface of the product.

### Trademarks

All trademarks are recognized, even if not explicitly identified as such. Missing designations do not mean that a product or brand is not a registered trademark.

### SMA Solar Technology AG

Sonnenallee 1

34266 Niestetal

Germany

Tel. +49 561 9522-0

Fax +49 561 9522-100

[www.SMA.de](http://www.SMA.de)

Email: [info@SMA.de](mailto:info@SMA.de)

As of: 6/9/2020

Copyright © 2020 SMA Solar Technology AG. All rights reserved.

# Table of Contents

<b>1</b>	<b>Information on this Document .....</b>	<b>5</b>
1.1	Validity .....	5
1.2	Target Group .....	5
1.3	Content and Structure of this Document .....	5
1.4	Levels of Warning Messages .....	5
1.5	Symbols in the Document .....	6
1.6	Typographical Elements in the Document .....	6
1.7	Designations in the Document .....	6
1.8	Additional Information .....	7
<b>2</b>	<b>Safety .....</b>	<b>8</b>
2.1	Intended Use .....	8
2.2	IMPORTANT SAFETY INSTRUCTIONS.....	8
2.3	Supported Products .....	11
<b>3</b>	<b>Scope of Delivery .....</b>	<b>13</b>
<b>4</b>	<b>Product Overview .....</b>	<b>14</b>
4.1	Product Description .....	14
4.2	Symbols on the Product .....	15
4.3	Function Button .....	16
4.4	LED Signals .....	16
4.5	Sunny Portal.....	18
4.6	Interfaces and Functions .....	18
<b>5</b>	<b>Mounting.....</b>	<b>22</b>
5.1	Requirements for Mounting .....	22
5.2	Mounting the product .....	23
<b>6</b>	<b>Connection .....</b>	<b>25</b>
6.1	Overview of the Connection Area .....	25
6.2	Preparing the Connection Cable.....	25
6.3	Connecting Signal Source to Digital Input .....	25
6.4	Connecting RS485 Devices.....	27
6.5	Connecting the network.....	29
6.6	Connecting the Voltage Supply .....	30
<b>7</b>	<b>Commissioning .....</b>	<b>33</b>
7.1	Establishing a direct connection via WLAN .....	33

7.2	Establishing a Connection via Ethernet in the local network .....	34
7.3	Commissioning the Product .....	35
7.4	Registering in Sunny Portal .....	36
<b>8</b>	<b>Operation .....</b>	<b>39</b>
8.1	Design of the User Interface .....	39
8.2	User Groups and User Rights .....	40
8.3	Configuring Limitation of Active Power Feed-In .....	41
8.4	Configuring Reactive Power as a Function of Grid Voltage .....	43
8.5	Configuring Modbus Devices .....	44
8.6	Configuring a System with several Data Managers .....	45
8.7	Speedwire Encryption of the System Communication .....	46
8.8	Switching Digital Outputs Based on Thresholds .....	46
<b>9</b>	<b>Firmware Update .....</b>	<b>48</b>
9.1	Updating the Product Firmware .....	48
9.2	Updating the Firmware of Connected SMA Products .....	49
<b>10</b>	<b>Troubleshooting .....</b>	<b>50</b>
<b>11</b>	<b>Decommissioning the Product .....</b>	<b>52</b>
<b>12</b>	<b>Technical Data .....</b>	<b>53</b>
<b>13</b>	<b>Accessories .....</b>	<b>55</b>
<b>14</b>	<b>Contact .....</b>	<b>56</b>
<b>15</b>	<b>EU Declaration of Conformity .....</b>	<b>59</b>
<b>16</b>	<b>Compliance Information .....</b>	<b>60</b>

# 1 Information on this Document

## 1.1 Validity

This document is valid for:

- EDMM-10 (Sunny Data Manager M) from firmware version 1.08.01.R.
- EDMM-US-10 (Sunny Data Manager M) from firmware version 1.08.01.R.
- Sunny Portal powered by ennexOS

## 1.2 Target Group

The tasks described in this document must only be performed by qualified persons. Qualified persons must have the following skills:

- Training in the installation and configuration of IT systems
- Training in how to deal with the dangers and risks associated with installing, repairing and using electrical devices and installations
- Training in the installation and commissioning of electrical devices and installations
- Knowledge of all applicable laws, standards and directives
- Knowledge of and compliance with this document and all safety information

## 1.3 Content and Structure of this Document

This document describes the mounting, installation, commissioning, configuration, operation, troubleshooting and decommissioning of the product as well as the operation of the product user interface.

You will find the latest version of this document and further information on the product in PDF format and as eManual at [www.SMA-Solar.com](http://www.SMA-Solar.com). You can also call up the eManual via the user interface of the product.

Illustrations in this document are reduced to the essential information and may deviate from the real product.

## 1.4 Levels of Warning Messages

The following levels of warning messages may occur when handling the product.

### DANGER

Indicates a hazardous situation which, if not avoided, will result in death or serious injury.

### WARNING

Indicates a hazardous situation which, if not avoided, could result in death or serious injury.



### CAUTION

Indicates a hazardous situation which, if not avoided, could result in minor or moderate injury.

## NOTICE

Indicates a situation which, if not avoided, can result in property damage.

## 1.5 Symbols in the Document

Symbol	Explanation
	Information that is important for a specific topic or goal, but is not safety-relevant
<input type="checkbox"/>	Indicates a requirement for meeting a specific goal
<input checked="" type="checkbox"/>	Desired result
	A problem that might occur
	Example

## 1.6 Typographical Elements in the Document

Typography	Use	Example
<b>bold</b>	<ul style="list-style-type: none"> <li>Messages</li> <li>Terminals</li> <li>Elements on a user interface</li> <li>Elements to be selected</li> <li>Elements to be entered</li> </ul>	<ul style="list-style-type: none"> <li>Connect the insulated conductors to the terminals <b>X703:1</b> to <b>X703:6</b>.</li> <li>Enter <b>10</b> in the field <b>Minutes</b>.</li> </ul>
>	<ul style="list-style-type: none"> <li>Connects several elements to be selected</li> </ul>	<ul style="list-style-type: none"> <li>Select <b>Settings &gt; Date</b>.</li> </ul>
[Button] [Key]	<ul style="list-style-type: none"> <li>Button or key to be selected or pressed</li> </ul>	<ul style="list-style-type: none"> <li>Select <b>[Enter]</b>.</li> </ul>
#	<ul style="list-style-type: none"> <li>Placeholder for variable components (e.g., parameter names)</li> </ul>	<ul style="list-style-type: none"> <li>Parameter <b>WCtHz.Hz#</b></li> </ul>

## 1.7 Designations in the Document

Complete designation	Designation in this document
SMA Data Manager M	Data Manager, product
SMA Speedwire fieldbus	SMA Speedwire network, Speedwire
SMA Speedwire Encrypted Communication	Speedwire encryption
Sunny Portal powered by ennexOS	Sunny Portal

## 1.8 Additional Information

Title and information content	Type of information
"Direct Marketing Interface"	Technical information
"SMA Modbus® Interface - SMA DATA MANAGER"	Technical Information
"PUBLIC CYBER SECURITY - Guidelines for a Secure PV System Communication"	Technical information
"RS485 Verkabelungsprinzip / Cabling Plan - SMA Data Manager M"	Technical Information
"SMA DATA MANAGER / SUNNY PORTAL powered by ennexOS - Functions"	Technical Information
"SMA SPEEDWIRE FIELDBUS"	Technical information
"SUNNY PORTAL powered by ennexOS"	User Manual
"WAGO-I/O-SYSTEM 750 with SMA DATA MANAGER M"	Installation Manual
Answers to frequently asked questions	FAQ on product page
User information on the operation and features of the product	User information on the user interface

## 2 Safety

### 2.1 Intended Use

The SMA Data Manager M is a data logger that acts as a system gateway and energy manager. PV system components and PV systems are integrated into the SMA infrastructure via the SMA Data Manager M. This includes energy generators and loads, I/O systems and energy meters. The SMA Data Manager M supports communication with up to 50 devices such as PV inverters, battery inverters, energy meters and I/O systems.

The product is designed for indoor use only.

The product conforms with the EU grid connection conditions according to regulation (EU) 2016/631.

All components must remain within their permitted operating ranges and their installation requirements at all times.

Use SMA products only in accordance with the information provided in the enclosed documentation and with the locally applicable laws, regulations, standards and directives. Any other application may cause personal injury or property damage.

Alterations to the SMA products, e.g., changes or modifications, are only permitted with the express written permission of SMA Solar Technology AG. Unauthorized alterations will void guarantee and warranty claims and in most cases terminate the operating license. SMA Solar Technology AG shall not be held liable for any damage caused by such changes.

Any use of the product other than that described in the Intended Use section does not qualify as the intended use.

The enclosed documentation is an integral part of this product. Keep the documentation in a convenient, dry place for future reference and observe all instructions contained therein.

This document does not replace and is not intended to replace any local, state, provincial, federal or national laws, regulations or codes applicable to the installation, electrical safety and use of the product. SMA Solar Technology AG assumes no responsibility for the compliance or non-compliance with such laws or codes in connection with the installation of the product.

The type label must remain permanently attached to the product.

### 2.2 IMPORTANT SAFETY INSTRUCTIONS

Keep the manual for future reference.

This section contains safety information that must be observed at all times when working.

The product has been designed and tested in accordance with international safety requirements. As with all electrical or electronic devices, there are residual risks despite careful construction. To prevent personal injury and property damage and to ensure long-term operation of the product, read this section carefully and observe all safety information at all times.



**⚠ WARNING****Danger to life due to electric shock**

Under fault conditions, when working on the power supply circuit there may be dangerous voltages present on the product. This can result in death or serious injury.

- For power supply units with a fixed connection, make sure that a disconnection unit (e.g. miniature circuit breaker) is present outside the power supply unit.
- For power supply units with a plug connection, make sure that the electrical outlet for the power supply unit is close to the power supply unit.
- The disconnection unit and the electrical outlet for the power supply unit must be freely accessible at all times.

**⚠ CAUTION****Damage due to electromagnetic radiation**

This product emits electromagnetic radiation during operation, which may interfere with the operation of other devices and active body aids (e.g. pacemakers).

- Persons must not remain closer than 20 cm (8 in) to the product for long periods of time.

**NOTICE****Damage to the product due to condensation**

If the product is moved from a cold environment to a warm environment, condensation may form in the product. This can damage the product or impair its functionality.

- When there are large temperature differences, wait until the product has reached room temperature to connect the voltage supply.
- Make sure the product is dry.

**NOTICE****Manipulation of PV system data in networks**

You can connect the supported SMA products to the Internet. When connected to the Internet, there is a risk that unauthorized users can access and manipulate the data of your PV system.

- Set up a firewall.
- Close unnecessary network ports.
- If absolutely necessary, only enable remote access via a virtual private network (VPN).
- Do not use the port forwarding feature. This also applies to the used Modbus ports.
- Disconnect system components from other network components (network segmentation).

## NOTICE

### High costs due to inappropriate Internet tariff

Depending on use, the data volume of the product transferred via the Internet may vary in size. The data volume depends, for example, on the number of devices in the system, the frequency of device updates, the frequency of data transfer to Sunny Portal or the use of FTP push. High costs for the Internet connection can be the result.

- SMA Solar Technology AG recommends using an Internet flat rate with a monthly data volume of at least 1 GB for systems with up to five SMA products.
- SMA Solar Technology AG recommends using an Internet flat rate with a monthly data volume of at least 3 GB for systems with up to 50 SMA products.
- SMA Solar Technology AG recommends a data transfer rate of at least 10 Mbit/s for flat-rate surfing.

### **i** Electrical installations (for North America)

All installations must conform with the laws, regulations, codes and standards applicable in the jurisdiction of installation (e.g. *National Electrical Code*® ANSI/NFPA 70 or *Canadian Electrical Code*® CSA-C22.1.).

- Before connecting the product to the utility grid, contact your local grid operator. The electrical connection of the product must be carried out by qualified persons only.
- Ensure that the cables or conductors used for electrical connection are not damaged.

### **i** DHCP Server is recommended.

The DHCP server automatically assigns the appropriate network settings to your nodes in the local network. A manual network configuration is therefore not necessary. In a local network, the Internet router is usually the DHCP server. If the IP addresses in the local network are to be assigned dynamically, DHCP must be activated in the Internet router (see the Internet router manual). In order to receive the same IP address by the internet router after a restart, set the MAC address binding.

In networks where no DHCP server is active, proper IP addresses must be assigned from the free address pool of the network segment to all network participants to be integrated during commissioning.

### **i** IP addresses of Modbus devices

In systems with Modbus devices, static IP addresses must be assigned to all Modbus devices. Suitable IP addresses can be assigned to the Modbus devices from the free address supply of the network segment either manually or dynamically via DHCP.

If the IP addresses are to be assigned dynamically, DHCP must be activated in the router (see the router manual). Make sure that the Modbus devices do not contain variable IP addresses but always the same IP addresses.

This also applies to data managers that are used as subordinated devices (slaves).

### **i** Completion of data after interruption of communication

If the data communication between the Data Manager and SMA products connected via SMA Speedwire is interrupted, the data will be retrieved subsequently for the time of the interruption. Data is retrieved with a maximum interruption period of 7 days. Existing data of newly connected SMA products will not be transmitted until the Data Manager is commissioned. Historical data of SMA products are only available in the user interface of the SMA product.

Possible causes for the interruption of the data communication can be:

- Interruptions of the SMA Speedwire connection
- Resetting connected SMA products over a period of several hours
- Voltage supply interruption

## 2.3 Supported Products

### Supported SMA Products

#### **i** Availability of SMA products in your country

Not all SMA products are available in all countries. For information on whether an SMA product is available in your country, contact your distributor.

#### Inverters:

- All SMA inverters with integrated or retrofitted Speedwire/Webconnect interfaces are supported. Information on whether an SMA inverter has an integrated Speedwire/Webconnect interface or can be retrofitted with a Speedwire/Webconnect interface can be found on the SMA inverter product page at [www.SMA-Solar.com](http://www.SMA-Solar.com).

#### Other products:

- SMA Com Gateway from firmware version 1.0.28.R
- SMA Energy Meter from firmware version 1.1 (not available in all countries)
- Sunny Portal powered by ennexOS
- 1 SMA Inverter Manager with 1 Sunny Tripower Storage 60
- 1 SMA Inverter Manager with up to 42 Sunny Tripower 60 / Sunny Highpower Peak1

### Supported Products from Other Manufacturers

#### Inverters:

- FLX and TLX series inverters with Danfoss EtherLynx protocol from Danfoss Solar Inverters A/S

#### Energy meters:

- DTS 307 from Measurlogic, Inc.
- PAC2200 from Siemens
- Power Analyser of the UMG 604 series from Janitza electronics GmbH
- UMD 705 from PQ Plus GmbH
- WattNode Modbus of the WNC series from Continental Control Systems, LLC

- WattsOn-Mark II Precision Energy Meter from Elkor Technologies Inc.

#### **External I/O Systems:**

- ioLogik E1241 of Moxa Europe GmbH (see Section 13 "Accessories", page 55)
- ioLogik E1242 of Moxa Europe GmbH (see Section 13 "Accessories", page 55)
- ioLogik E1260 of Moxa Europe GmbH (see Section 13 "Accessories", page 55)
- WAGO-I/O-SYSTEM 750 of WAGO Kontakttechnik GmbH & Co. KG (see Section 13 "Accessories", page 55)

#### **Sensors (via Modbus interface):**

- Irradiation sensors
- Anemometers
- Temperature sensors
- Fill level sensors
- Weather stations (e.g. PVMET-200 from RainWise, Inc.)

#### **Sensors (in conjunction with external I/O systems):**

- Irradiation sensors that can output a current signal in the range from 4 mA to 20 mA
- Anemometers that can output a current signal in the range from 4 mA to 20 mA
- Temperature sensors with a Pt100 measuring shunt

The linearization of the temperature sensors' data takes place in the I/O system. In the case of solar irradiation sensors and anemometers, however, the sensor itself must be designed for a linearization of the data.

#### **Sensors (via connected SMA inverters):**

The following sensors that are connected to an SMA inverter are supported (for connection options see the inverter manual):

- Irradiation sensors
- Anemometers
- Temperature sensors

#### **Signal receivers and digital signal sources:**

- Signal sources with relay contacts

#### **Routers and network switches:**

- Routers and network switches for Fast Ethernet with a data transfer rate of at least 100 Mbit/s. All network components used must support version 2 or version 3 (IGMPv2 or IGMPv3) of the IGMP protocol. Do not use an IGMP Snooping Switch as per RFC 4541.

### 3 Scope of Delivery

Check the scope of delivery for completeness and any externally visible damage. Contact your distributor if the scope of delivery is incomplete or damaged.

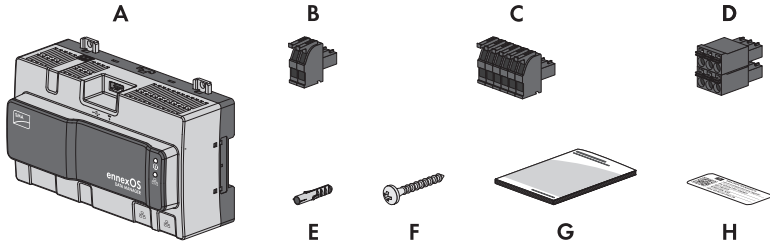

Figure 1: Components included in the scope of delivery

Position	Quantity	Designation
A	1	SMA Data Manager
B	1	Two-pole plug
C	1	Six-pole plug
D	1	Six-pole plug
E	4	Screw anchors
F	4	Screws
G	1	Quick Reference Guide
H	2	Label with Internet address, registration ID (RID) and identification key (PIC) for product registration in Sunny Portal powered by en-nexOS

## 4 Product Overview

### 4.1 Product Description

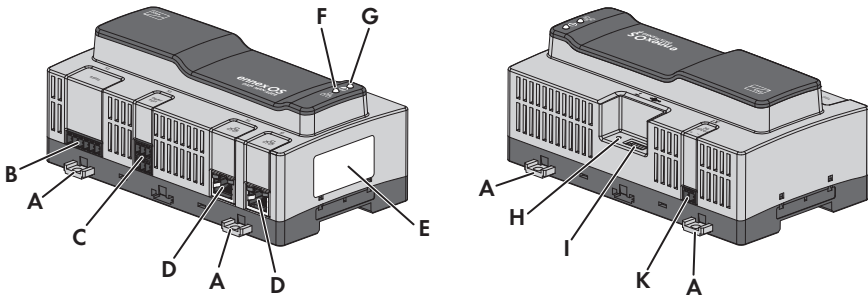















Figure 2: Design of the product

Position	Designation
A	Press-out brackets for wall mounting
B	Jack for connecting the RS485 devices
C	Jack for the connection of digital signals
D	Network ports with status LEDs for connecting to the network
E	Type label The type label clearly identifies the product. You will require the information on the type label to use the product safely and when seeking customer support from the SMA Service Line. You will find the following information on the type label: <ul style="list-style-type: none"> <li>• Device type (Type)</li> <li>• Serial number</li> <li>• Date of manufacture</li> <li>• Device-specific characteristics</li> <li>• Registration ID (RID)</li> <li>• Identification key (PIC)</li> </ul>
F	COM LED The COM LED, together with the system LED, indicates the operating state of the product (see Section 4.4 "LED Signals", page 16).
G	System LED The system LED, together with the COM LED, indicates the operating state of the product (see Section 4.4 "LED Signals", page 16).
H	Function button

Position	Designation
I	USB 2.0 ports for manual updates
J	Jack for connection of the voltage supply

## 4.2 Symbols on the Product

Symbol	Explanation
	USB
	Function button
	System LED
	Ethernet
	WEEE designation Do not dispose of the product together with the household waste but in accordance with the disposal regulations for electronic waste applicable at the installation site.
	The product is suitable for indoor installation.
	CE marking The product complies with the requirements of the applicable EU directives.
	RoHS labeling The product complies with the requirements of the applicable EU directives.
	FCC designation The product complies with the requirements of the applicable FCC standards.
	RCM (Regulatory Compliance Mark) The product complies with the requirements of the applicable Australian standards.
	This equipment contains specified radio equipment that has been certified to the Technical Regulation Conformity Certification under the Radio Law.
	ICASA The product complies with the requirements of the South African standards for telecommunication.

Symbol	Explanation
	<p>ANATEL</p> <p>The product complies with the requirements of the Brazilian standards for telecommunication.</p> <p>Este equipamento opera em caráter secundário, isto é, não tem direito a proteção contra interferência prejudicial, mesmo de estações do mesmo tipo, e não pode causar interferência a sistemas operando em caráter primário.</p>
	<p>The product complies with the Moroccan safety and EMC requirements for electronic products.</p>

## 4.3 Function Button

Depending on how long it is activated for, the function button performs the following functions:

- 1 to 5 seconds: no effect
- 5 to 10 seconds: restarts the Data Manager
- 10 to 15 seconds: resets password and administrator account of the Data Manager
- 15 to 20 seconds: resets the Data Manager to the default settings
- Longer than 20 seconds: no effect

The length of time the function button has been activated for is indicated via LED signals (see Section 4.4 "LED Signals", page 16).

## 4.4 LED Signals

### System- and COM LED

The LEDs indicate the operating state and communication status of the product. Not relevant operating states are shown as "-".

System LED ⓘ	COM LED ☐☐	Explanation
<b>Startup process</b>		
Off	Off	No power supply or no boot up procedure.
Glowing orange	Glowing orange	Boot up procedure started.
Flashing green	-	User interface is being loaded.
Glowing green	Glowing orange	Communication is being started.
Glowing red	Off	Boot up procedure running.
Glowing red (for longer than 2 minutes)	Off	Errors during the Booting Procedure
Glowing green	-	Normal operation
Flashing red	-	System error



System LED ⓘ	COM LED 	Explanation
Flashing orange	-	Update procedure running.
<b>Communication status</b>		
-	Flashing orange and green in alternation	WLAN access point is activated.
-	Flashing green	Connection to all devices is established.
-	Flashing orange	Connection to Sunny Portal is disrupted.
-	Glowing orange	Connection to at least one device is disrupted.
-	Glowing red	Connection to all devices is disrupted.
<b>Function button</b>		
Flashing orange and green in alternation	Off	Function button has been pressed for less than 5 seconds.
Flashing orange and green in alternation	Glowing green	Function button has been pressed for between 5 and 10 seconds.
Flashing orange and green in alternation	Glowing orange	Function button has been pressed for between 10 and 15 seconds.
Flashing orange and green in alternation	Glowing red	Function button has been pressed for between 15 and 20 seconds.
Glowing green	Off	Function button has been pressed for longer than 20 seconds.

## Network port LEDs

### The colors of the network port LEDs and what each color indicates are not standardized

The colors used by SMA Solar Technology AG for the Link LED and the Activity LED and what each color indicates may be different to those used in third-party products.

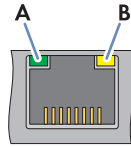

Figure 3: Network port LEDs

Position	Designation	Color	Explanation
A	Link LED	Green	Shows the network connection status.
B	Activity LED	Yellow	Shows network connection activity.

## 4.5 Sunny Portal

Sunny Portal is an Internet portal which enables you to monitor systems and to visualize system data.

The Sunny Portal serves as the user interface for the extended configuration of the product, of system sections, systems, system groups and the entire system portfolio. The Sunny Portal monitors and analyzes the system and its components on all levels.

There are two Sunny Portal versions: the classical Sunny Portal (<https://www.sunnyportal.com>) and the newly developed Sunny Portal powered by ennexOS (<https://ennexOS.sunnyportal.com>). Both systems differ in their supported functions. With an existing user account, you can log into both portals, the Sunny Design (system planning software from SMA) as well as the app SMA 360°.

## 4.6 Interfaces and Functions

The product can be equipped or retrofitted with the following interfaces and functions: The availability of the functions depends on the product version and additional options purchased.

For further information on current and future functions, refer to the product page at [www.SMA-Solar.com](http://www.SMA-Solar.com).

### User interface for monitoring and configuration

The product is equipped as standard with an integrated webserver, which provides a user interface for configuring and monitoring the product.

The product user interface can be called up via the web browser if there is an existing connection to an end device (e.g. computer or tablet PC).

Connected SMA products can be configured and commissioned via the user interface of the product.

### Wi-Fi access point

The product is equipped with a Wi-Fi interface as standard. By tapping twice on the product, a Wi-Fi access point is activated. This point is used to connect the product to an end device (e.g. computer or tablet PC). This allows to carry out commissioning and configuration via direct Wi-Fi connection on site regardless of the wired network.

## SMA Speedwire

The product is equipped with SMA Speedwire as standard. SMA Speedwire is a type of communication based on the Ethernet standard. SMA Speedwire is designed for a data transfer rate of 100 Mbps and enables optimum communication between Speedwire devices within systems.

The products supports the encrypted system communication with SMA Speedwire Encrypted Communication. In order to be able to use the Speedwire encryption in the system, all Speedwire devices, except for the SMA Energy Meter, must support the function SMA Speedwire Encrypted Communication.

## Dashboard

On the dashboard of the user interface, information on the product, the plant and its components is displayed clearly and at a glance using widgets. The dashboard display can vary depending on the system's functional scope and user rights.

Information, such as yield forecast, system section visualization and inverter comparison, are available via the extended functions in Sunny Portal.

## Modbus

The product is equipped with two Modbus interfaces. One interface can be controlled via Ethernet (Modbus TCP) and the other interface via RS485 (Modbus RTU).

The Modbus interfaces have the following tasks:

- Remote query of measured values
- Setpoint specifications for system control

The Modbus interfaces differ in their function as:

- Modbus server and
- Modbus client.

The function of the Modbus server is available via the Ethernet interface (Modbus TCP). The Modbus server can be used for external access to the product (e.g. via SCADA systems).

The function of the Modbus client is available via the Ethernet interface (Modbus TCP) and the RS485 interface (Modbus RTU). The Modbus client can be used for communication with connected Modbus devices (e.g. inverters, energy meters, I/O systems).

For the communication with connected Modbus devices, predefined Modbus profiles and user-created Modbus profiles can be used. User-created Modbus profiles can be exported and transferred to another product.

## SunSpec Modbus

The product supports the standardized SunSpec Modbus profile via the interface of the Modbus client (Modbus TCP/RTU). The SunSpec Modbus profile from the SunSpec Alliance contains a comprehensive set of measured values and parameters for Modbus devices in decentralized power generation systems (e.g. inverters, energy meters, weather stations). The product has data points of the SunSpec Alliance and therefore conforms with the SunSpec Modbus profile of the underlying specification version (see [www.sunspec.org](http://www.sunspec.org)). Connected Modbus devices compatible with the SunSpec Modbus profile are automatically integrated into the system with the appropriate Modbus profile.

## Plant-wide parameterization

You can use the system parameter assistant to change the parameters of connected devices at the same time and to compare them. Simply select the desired devices from a list and change the parameters. The status of the parameter changes is accessible at all times.

## Energy monitoring

Several SMA Energy Meters and Modbus energy meters from other manufacturers can be connected for comprehensive energy monitoring. The product can also read out, save and display the generation and consumption data of the meters.

In addition, energy meters (e.g. a gas meter) can be registered via the extended functions in Sunny Portal. The meter readings can be entered manually and displayed.

## FTP Push

The FTP Push function can be used to upload collected system data to a freely selectable external FTP server. The collected system data is uploaded to the specified folder up to 1 time per hour per day. Here, the system data is exported in an unchangeable XML format. The system data and user data is transmitted via standard FTP protocol to the FTP server without encryption.

## SMA Smart Connected

SMA Smart Connected is the free monitoring of the product via the SMA Sunny Portal. Thanks to SMA Smart Connected, the operator and qualified person will be informed automatically and proactively about product events that occur.

SMA Smart Connected is activated during registration in Sunny Portal. In order to use SMA Smart Connected, it is necessary that the product is permanently connected to Sunny Portal and the data of the operator and qualified person is stored in Sunny Portal and up-to-date.

SMA Smart Connected can only be used in Sunny Portal when this feature is supported by the inverters.

## Grid management services

The product is equipped with service functions for grid management.

Depending on the requirements of the grid operator, you can activate and configure the functions (e.g. active power limitation) via operating parameters.

The setpoints from the grid operator can either be implemented via open-loop control or closed-loop control. For this, the setpoints are specified via Modbus, via analog or digital signals or manually in the installation assistant. The implementation of the setpoints is reported back to the grid operator.

## Active power limitation

The setpoint for active power limitation is specified in percent. The total system power is taken as the reference value. For this, the setpoints are specified via Modbus, via analog or digital signals or manually in the installation assistant.

## Zero export

Some grid operators permit connection of PV systems only on condition that no active power is fed into the utility grid. The PV energy is therefore consumed exclusively at the place where it is generated.

This product enables the limitation of the active power feed-in of the connected SMA inverters and inverters of other manufacturers, provided these are connected via SunSpec Modbus and support this function, to 0% with active closed-loop control of specifications at the grid-connection point.

### **Reactive Power Control**

The reactive power control can take place through direct parameter settings ( $Q$ ,  $\cos \varphi$ ) in the installation assistant or a variable specification from the grid operator via the Modbus interface or via analog signals. The reactive power control as characteristic curve function can also be regulated as a function of the voltage at the grid-connection point  $Q(V)$ . The values are specified as a percentage of the maximum AC power. A proper meter for measuring the relevant electrical variables ( $V$ ,  $P$ ,  $Q$ ) is required at the grid-connection point. A suitable energy meter is also required at the point of interconnection for  $\cos \varphi$  specifications in control mode.

### **Direct marketing**

A direct marketer can use the product for remotely controlling the system via the built-in direct marketing interface. In this process, control signals of the direct marketer are transferred to the system. The function is activated via the installation assistant of the grid management services in the product.

## 5 Mounting

### 5.1 Requirements for Mounting

#### Requirements for mounting location:

#### WARNING

##### **Danger to life due to fire or explosion**

Despite careful construction, electrical devices can cause fires. This can result in death or serious injury.

- Do not mount the product in areas containing highly flammable materials or gases.
- Do not mount the product in potentially explosive atmospheres.

#### CAUTION

##### **Damage due to electromagnetic radiation**

This product emits electromagnetic radiation during operation, which may interfere with the operation of other devices and active body aids (e.g. pacemakers).

- Persons must not remain closer than 20 cm (8 in) to the product for long periods of time.

- A solid, flat support surface must be available for mounting.
- The mounting location must be inaccessible to children.
- The mounting location must be suitable for the weight and dimensions of the product  
Section 12, page 53.
- The mounting location should be freely and safely accessible at all times without the need for any auxiliary equipment (such as scaffolding or lifting platforms). Non-fulfillment of these criteria may restrict servicing.
- All ambient conditions must be met Section 12, page 53.
- The labelling on the product must be readable after installation.

#### **Permitted and prohibited mounting positions:**

- The product may only be mounted in a horizontal position.

**Dimensions for mounting:**

Figure 4: Dimensions for wall mounting (Dimensions in mm (in))

**Recommended clearances:**

- A clearance of 50 mm (2 in) must be observed above and below to other objects.

## 5.2 Mounting the product

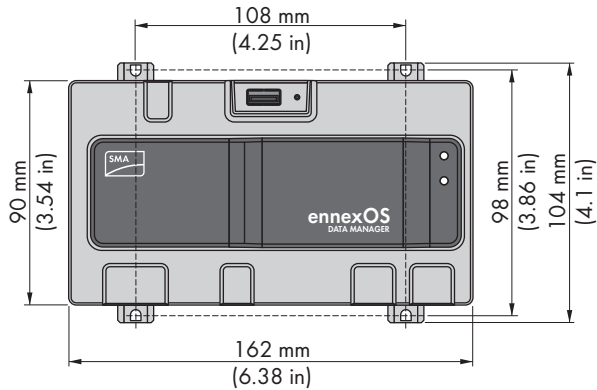
There are two options for mounting the product:

- Mounting on the top-hat rail
- Mounting on a wall

### Mounting the Product on the DIN rail

**Additionally required mounting material (not included in the scope of delivery):**

- Top-hat rail (TH 35-7.5)

**Requirement:**

- The top-hat rail must be securely mounted.

**Procedure:**

1. Place the product onto the DIN rail from above and hook it into place.

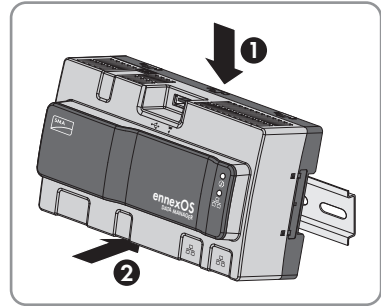

- ☑ The product snaps audibly into place.
2. Ensure that the product is securely in place.

**Mounting the Product on the Wall**

1. Press the four brackets on the back side of the Product out from the inside.

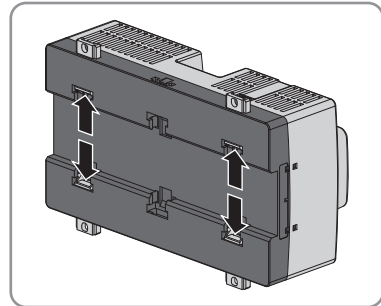

- ☑ The brackets snap into place.
2. Mark the drill holes using the brackets as a template.
  3. Drill the holes and insert the provided screw anchors. Do not drill through the brackets.
  4. Insert the provided screws through the brackets and tighten. Do not damage the brackets.

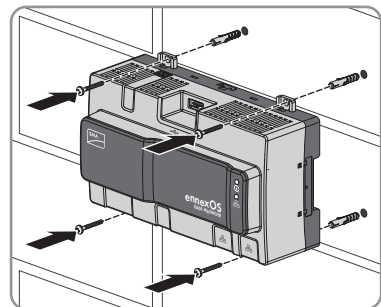

5. Ensure that the product is securely in place.



## 6 Connection

### 6.1 Overview of the Connection Area

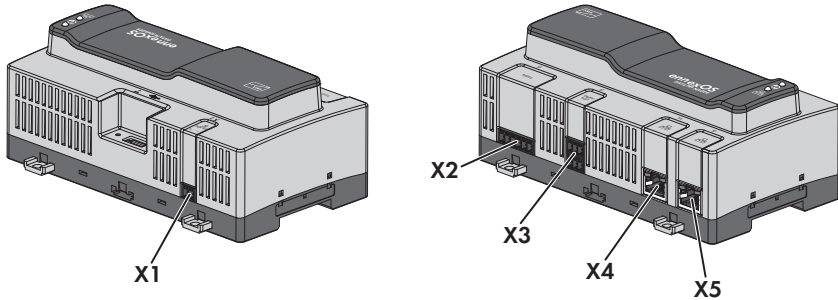

Figure 5: Overview of the connection area

Connection	Explanation
X1	Jack for connecting the voltage supply
X2	Jack for connecting the RS485 devices
X3	Jack for the connection of digital signals
X4	Network port with status LEDs for connecting to the SMA Speedwire network
X5	Network port with status LEDs for connecting to the SMA Speedwire network

### 6.2 Preparing the Connection Cable

Always proceed as follows to prepare each connection cable for connection to multipole plugs.

#### Procedure:

1. Strip 40 mm (1.57 in) of cable sheath from the end of the connection cable to which the multipole plug is to be attached. When doing so, ensure that no pieces of cable fall into the enclosure.
2. Strip off 6 mm (0.24 in) of the conductor insulation from each of the required connection cable conductors.
3. Trim unneeded insulated conductors of the connection cable flush with the cable sheath.
4. Push one bootlace ferrule onto each stripped insulated conductor up to the stop, if necessary.

### 6.3 Connecting Signal Source to Digital Input

Digital signals for the active power supply can be transmitted to the jack **X3**. A ripple control receiver or a remote terminal unit can be used as a digital signal source, for example.

- Digital signal source with up to 4 potential-free contacts
- Connection cable

**Requirements:**

- The signal source must be technically suitable for connection to the digital inputs (see Section 12, page 53).
- The connection cable must be prepared for connection to the multipole terminal block (see Section 6.2, page 25).

**Overview:**

Figure 6: Pin assignment

Pin	Pin assignment	Explanation
1	DI1	Digital Input
2	DI2	Digital Input
3	DI3	Digital Input
4	DI4	Digital Input
5	DI5	Fast-stop*
6	24 V	Voltage supply output

\* With the fast stop function, depending on the set inverter operating mode, inverters can be disconnected from the utility grid or enter into standby operation. For further information on SMA products with fast stop function see manual of the SMA products.

**Circuitry overview:**

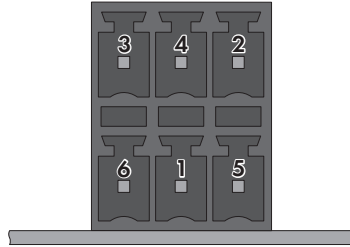
Figure 7: Connection of a Ripple Control Receiver

1. Connect the connection cable to the digital signal source (see the manual from manufacturer).
2. Connect the connection cable to the supplied six-pole plug. For this, unlock the required terminal positions using a suitable tool and plug the conductors into these terminal positions.
3. Connect the six-pole plug to terminal **X3**. Observe the pin assignment.
4. Note the terminal assignment.

## 6.4 Connecting RS485 Devices

The product is suitable for the communication with RS485 devices via Modbus RTU.

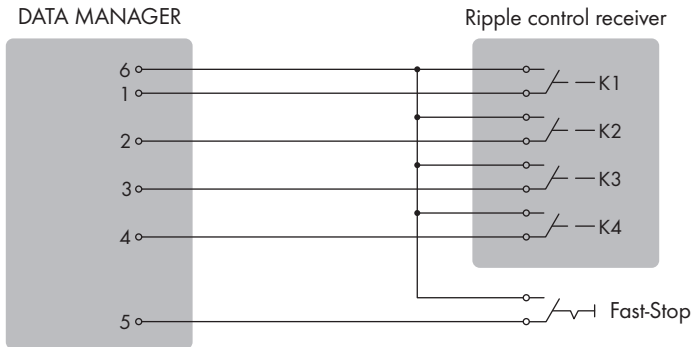
The bytes in the product are set as follows and may need to be adjusted in the RS485 device.

Structure:	8 data bits
	1 stop bit
	No parity

**Cable requirements:**

The cable length and quality affect the quality of the signal. Observe the following cable requirements.

- Number of insulated conductor pairs and insulated conductor cross-section: at least 2 x 2 x 0.22 mm<sup>2</sup> (2 x 2 x 24 AWG)
- Maximum cable length across the entire RS485 bus: 1200 m (3937 ft)
- Twisted pair conductors
- Shielding: yes
- UV-resistant for outdoor use.

**Plug assignment:**

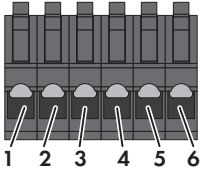
Plug	Position	Assignment
	1	Data+ (D+)
	2	Not assigned
	3	Ground (GND)
	4	Data- (D-)
	5	Line termination (optional)
	6	Line termination (optional)

**Requirements:**

- The same baud rate (1200 baud, 9600 baud or 19200 baud) must be set in all RS485 devices.

**Procedure:**

1. Dismantle 40 mm of the product end of the RS485 cable.
2. Strip the shielding to the same length as the cable sheath.
3. Shorten unused insulated conductors flush with the cable sheath.
4. Strip off the conductor insulation by 6 mm.
5. Release the conductor entries on the supplied six-pole plug.

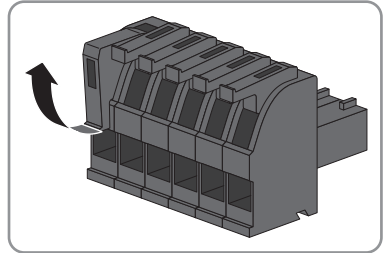

6. Connect the RS485 data cable conductors to the supplied six-pole plug. To do so, plug the conductors into the conductor entries and close the conductor entries. Observe the plug assignment.

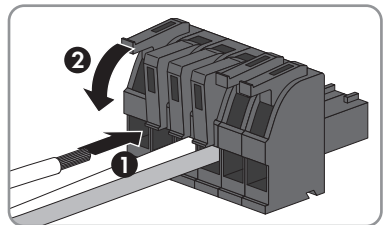

7. If the product is at the end of the RS485 bus, install a jumper wire as a line terminator between pin **5** and pin **6** on the six-pole plug.

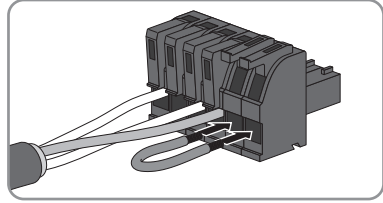

8. Plug the six-pole plug into the port **X2** on the product.

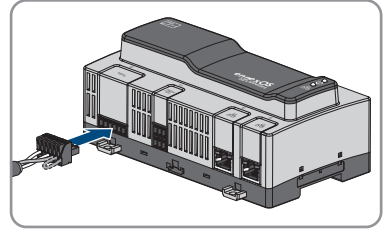

## 6.5 Connecting the network

### **i** Interference in data transmission due to unshielded power cables

If unshielded power cables are used, they generate an electromagnetic field during operation which may induce interference in network cables during data transmission.

- When laying network cables without separating strip, observe a minimum clearance of 200 mm (8 in) to unshielded energy cables.
- When laying network cables with separating aluminum strip, observe a minimum clearance of 100 mm (4 in) to unshielded energy cables.
- When laying network cables with separating steel strip, observe a minimum clearance of 50 mm (2 in) to unshielded energy cables.

### Additionally required material (not included in the scope of delivery):

- 1 network cable

### Network cable requirements:

The cable length and quality affect the quality of the signal. Observe the following cable requirements.

- Cable type: 100BaseTx
- Cable category: minimum CAT5e
- Plug type: RJ45 of Cat5, Cat5e, Cat6 or Cat6a (Cat7 plugs cannot be used)
- Shielding: S/UTP, F/UTP or higher
- Number of insulated conductor pairs and insulated conductor cross-section: at least 2 x 2 x 0.22 mm<sup>2</sup> (2 x 2 x 24 AWG)
- Maximum cable length between two nodes when using patch cables: 50 m (164 ft)
- Maximum cable length between two nodes when using installation cables: 100 m (328 ft)
- UV-resistant for outdoor use.

**Procedure:**

1. Plug the RJ45 plug of the network cable into the network port **X4** or **X5** until the RJ45 plug snaps into place. The assignment of the network cables to the ports is not relevant, as the ports constitute a switch function.
2. Connect the other end of the network cable to the network.

## 6.6 Connecting the Voltage Supply

### WARNING

#### Danger to life due to electric shock

Under fault conditions, when working on the power supply circuit there may be dangerous voltages present on the product. This can result in death or serious injury.

- For power supply units with a fixed connection, make sure that a disconnection unit (e.g. miniature circuit breaker) is present outside the power supply unit.
- For power supply units with a plug connection, make sure that the electrical outlet for the power supply unit is close to the power supply unit.
- The disconnection unit and the electrical outlet for the power supply unit must be freely accessible at all times.

### NOTICE

#### Damage to the product due to condensation

If the product is moved from a cold environment to a warm environment, condensation may form in the product. This can damage the product or impair its functionality.

- When there are large temperature differences, wait until the product has reached room temperature to connect the voltage supply.
- Make sure the product is dry.

#### Additionally required material (not included in the scope of delivery):

- 1 power supply unit
- 1 AC connection cable
- 1 connection cable for the connection of the power supply unit to the product

#### Requirements for the power supply unit:

- Short-circuit current: < 8 A
- Nominal output power: 5 W
- DC output voltage: 10 V to 30 V
- Compliance with the requirements on current sources with limited power in accordance with IEC 60950

### Requirements on the connection cable for connecting the power supply unit to the Data Manager:

- Core cross-section: 0.2 mm<sup>2</sup> to 1.5 mm<sup>2</sup> (32 AWG to 16 AWG)
- The cable must have at least two insulated conductors
- Maximum cable length: 3 m (9.8 ft)

### Plug assignment:

Plug	Position	Assignment
	1	Input voltage 10 to 30 V DC
	2	Ground (GND)

### Procedure:

1. Mount the power supply unit (see the manufacturer manual).
2. Connect the connection cable to the power supply unit (see the manufacturer manual). Make a note of the insulated conductor colors and trim the unused insulated conductors back to the cable sheath.
3. Release the conductor entries on the supplied two-pole plug.

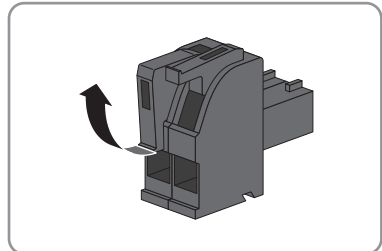

4. Connect the connection cable to the supplied two-pole plug. To do so, plug the conductors into the conductor entries and close the conductor entries. Observe the plug assignment.

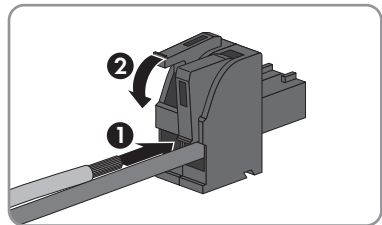

5. Trim unused insulated conductors flush with the cable sheath.
6. Plug the two-pole plug into the jack **X1** on the product.
7. Connect the AC connection cable to the power supply unit (see the manufacturer manual).

8.

**⚠ WARNING****Danger to life due to electric shock**

Lethal voltages are present at the connection point of the utility grid.

- Disconnect the connection point from voltage sources and ensure that the connection point is voltage-free.

9. Connect the other end of the AC connection cable to the voltage supply.

10. Connect the connection point to the utility grid.

The product starts operation (see Section 7 "Commissioning", page 33).



## 7 Commissioning

### 7.1 Establishing a direct connection via WLAN

#### Requirements:

- An end device (e.g. computer or tablet PC) must be available.
- The respective latest version of one of the following web browsers must be installed: Chrome, Edge, Firefox, Internet Explorer or Safari.
- JavaScript must be enabled in the web browser of the end device.

#### SSID, IP address and WLAN password

- SSID in WLAN: **SMA[serial number]** (e.g. SMA0123456789)
- Device-specific WLAN password: see WPA2-PSK on the inverter type label or the label included in delivery
- Standard IP address for a direct connection via WLAN outside of a local network:  
**192.168.12.3**

The procedure can be different depending on the end devices. If the procedure described does not apply to your end device, establish the direct connection via Wi-Fi as described in the manual of your end device.

There are two options to connect your end device to the Data Manager via Wi-Fi:

- By entering the Wi-Fi data located on the type label or the label included in delivery into your end device
- By scanning the QR code on the label included in delivery using your end device

#### Direct connection by entering the Wi-Fi data

##### Procedure:

1. Activate the Wi-Fi access point of the Data Manager. For this, tap on the enclosure lid twice.
  - The COM LED is intermittently flashing orange and green for approx. 5 seconds. The Wi-Fi access point is then activated for approx. 30 minutes. Once this period has expired, the Wi-Fi access point is deactivated automatically.
2. Search for Wi-Fi networks with your end device.
3. Select the SSID of the Data Manager **SMA[serial number]** in the list with the found Wi-Fi networks.
4. Enter the Wi-Fi (WPA2-PSK) password.
5. Open the web browser of your end device, enter the standard IP address 192.168.12.3 in the address line of the web browser and press the enter key.
  - The login page of the user interface opens.

#### Direct connection by scanning the QR code

##### Requirement:

- A QR code scanner or a corresponding camera function must be available on the end device.

**Procedure:**

1. Activate the Wi-Fi access point of the Data Manager. For this, tap on the enclosure lid twice.
  - The COM LED is intermittently flashing orange and green for approx. 5 seconds. The Wi-Fi access point is then activated for approx. 30 minutes. Once this period has expired, the Wi-Fi access point is deactivated automatically.
2. Scan the QR code on the label included in delivery using your end device.
3. Confirm the connection to the Wi-Fi access point of the Data Manager on your end device. It may be necessary to deactivate the mobile data connection on your end device.
4. Open the web browser of your end device, enter the standard IP address 192.168.12.3 in the address line of the web browser and press the enter key.
  - The login page of the user interface opens.

## 7.2 Establishing a Connection via Ethernet in the local network

### **i** Access addresses of the product

To connect a web browser to the product, the serial number of the product must be available. The serial number is part of the access addresses of the product.

- Access address for Apple and Linux systems: **SMA[serial number].local** (e.g. SMA0123456789.local)
- Access address for Windows and Android systems: **https://SMA[serial number]** (e.g. https://SMA0123456789)

### **i** Ports for data communication

In small local networks the use of certain ports is unrestricted. In industrial networks, the use of these ports may require authorization from the system administrator. For proper operation, the outgoing Internet connection of the product must allow the use of the following ports:

- Port 21 (FTP): Required for the FTP push function
- Port 123 (NTP): Required for time synchronization with a time server (if not provided by the Internet router)
- Port 443 (https/TLS): Required for data transfer of the product with Sunny Portal
- Port 9524 (TCP): Required for SMA Webconnect 1.5 and SMA SPOT

**Requirements:**

- The product must be connected to the local network via a network cable (e.g. via a router).
- The IPv4 protocol must be used.
- An end device (e.g. computer or tablet PC) must be available.
- The end device must be in the same local network as the product.
- The respective latest version of one of the following web browsers must be installed: Chrome, Edge, Firefox, Internet Explorer or Safari.
- JavaScript must be enabled in the web browser of the end device.

**Procedure:**

1. Open the web browser of your end device, enter the access address of the product in the address line of the web browser and press the enter key.
  2. **i** **Web browser signals a security vulnerability**  
 After the IP address has been entered, a message might appear indicating that the connection to the user interface of the product is not secure. SMA Solar Technology AG guarantees the security of the user interface.
    - Continue loading the user interface.
- The login page of the user interface opens after a few seconds.

## 7.3 Commissioning the Product

Once you have connected the product to the local network, the user interface login page opens.



Figure 8: Login page of the user interface

**Requirements:**

- All devices in the local network must be in operation and connected to the product via an Internet router.
- There must be an active Internet connection.
- An NTP server must be available in the local network or via the Internet. If there is no NTP server available, the time set in the web browser can be used as system time.

**i** **Restart at different system time**

An NTP server must be available in the local network or via the Internet. If there is no NTP server available, the time set in the web browser is used as system time. If the difference between the time in the web browser and the system time is more than one minute, the time is synchronized and the product restarted.

**Configuring the network settings**

- To configure the network settings, select **Change the network configuration**. Observe that the automatic network configuration is set by default via DHCP server and recommended by SMA Solar Technology AG.

- If the network settings are to be configured manually, select [**No**].
- Configure network settings and confirm with [**Save**].

### Starting the installation assistant

1. Select [**Continue**] on the login page of the user interface.
2. Create administrator account and select [**Next**]. Observe that only one user with administrator authorization can be created on each Data Manager.
  - The installation assistant will open.
3. Follow the installation assistant steps listed and make the settings appropriate for your system.
  - Device registration
  - Master and slave configuration
  - Meter configuration
  - Grid management services
  - A successful commissioning is confirmed by a message.

## 7.4 Registering in Sunny Portal

Once you have carried out the commissioning on the user interface of the product, you can make further system configurations in Sunny Portal. For this, all products of a system must be registered in Sunny Portal.

### Profiles for data communication

Different profiles are available to control the intensity of data communication in the system. The profiles can be edited at any time in Sunny Portal to adjust the intensity. Note that when switching from a low to a high intensity data communication, the data from the past is not retroactively adjusted. The adjustment applies from the date of the change. The following profile can be selected for data communication:

- High (default setting): Devices send all relevant data to the Sunny Portal every 5 minutes.
- Medium: Devices send all relevant data to the Sunny Portal every 15 minutes.
- Low: Devices send the most important data to the Sunny Portal 6 times per day.

### Requirements:

- The product must be in operation and connected to the local network via an Internet router.
- The registration ID (RID), identification key (PIC) and the Internet address of the type label or of other provided labels must be available.
- The system LED must glow green.
- An active Internet connection must be established.

### Procedure:

1. Call up the Internet address <https://ennexOS.SunnyPortal.com> in the web browser.
2. Register as a new user in Sunny Portal or log into Sunny Portal as an existing user.
3. Create a new system or add product to an existing system.

## Register as a new user in Sunny Portal.

1. Call up the Internet address <https://ennexOS.SunnyPortal.com> in the web browser.
2. Select **I require a user account**.
3. Enter the necessary data for registration.
4. Select [**Register**].
  - After a few minutes you will receive an e-mail containing a confirmation link for registration in Sunny Portal.
5. If you have not received an e-mail from Sunny Portal, check whether the e-mail has been redirected to a folder for junk mail or whether an incorrect e-mail address has been entered.
6. Follow the confirmation link in the e-mail within 48 hours.
  - Sunny Portal opens a separate window to confirm successful registration.
7. Call up the Internet address <https://ennexOS.SunnyPortal.com> in the web browser.
8. Enter the e-mail address and the Sunny Portal password in the fields **User** and **Password**.
9. Select [**Login**].

## Log in to Sunny Portal as an existing user.

### Requirements:

- You must have access to a user account in Sunny Portal, Sunny Places or Sunny Design.

### Procedure:

1. Call up the Internet address <https://ennexOS.SunnyPortal.com> in the web browser.
2. Enter the e-mail address and the Sunny Portal password in the fields **User** and **Password**.
3. Select [**Login**].

## Create new PV system

The system setup assistant is a step-by-step guide to the processes required for user registration and the registration of your system in Sunny Portal

### Service access

To ensure a better quality of service, activate the switch for service access during registration.

### Procedure:

1. Log into Sunny Portal.
2. Select the menu **Configuration**.
3. Select [**Create system**] in the context menu.
  - The system setup assistant opens.

## Add product to an existing system

### Procedure:

1. Log into Sunny Portal.
2. Select system.
3. Select the menu **Configuration**.

4. Select [**Device management**] in the context menu.
5. Select the  button.
  - The system setup assistant opens.

## 8 Operation

### 8.1 Design of the User Interface

The user interface of the SMA product (e.g. SMA Data Manager) and the user interface of Sunny Portal are uniform. The product is configured and commissioned on site via the user interface of the product.

The Sunny Portal serves as the user interface for the extended configuration of the product, of system sections, systems, system groups and the entire system portfolio. The Sunny Portal monitors and analyzes the system and its components on all levels.

The number of functions and menus depends on whether you are on the local user interface of the product or in Sunny Portal.



Figure 9: Design of the user interface (example)

Position	Designation	Description
A	Focus navigation	Enables the navigation between the following levels: <ul style="list-style-type: none"> <li>• System</li> <li>• Device</li> </ul>
B	User settings	Provides the following functions: <ul style="list-style-type: none"> <li>• Configuring personal data</li> <li>• Log out</li> </ul>
C	Notifications	Display of higher-level notifications for events in the system
D	System information	Displays the following information: <ul style="list-style-type: none"> <li>• System time</li> <li>• IP address</li> <li>• Firmware version</li> <li>• Serial number</li> <li>• Licenses</li> </ul>
E	Content area	Displays the dashboard or content of the selected menu
F	Configuration	Offers different configuration options, depending on the scope of the connected devices and the selected level.

Position	Designation	Description
G	Monitoring	Displays depending on the selected device the following information on the current level and the superior levels: <ul style="list-style-type: none"> <li>• Energy and power</li> <li>• Instantaneous values</li> <li>• Status list</li> <li>• Event monitor</li> </ul>
H	Dashboard	Displays information and instantaneous values of the device or system currently selected.
I	Home	Opens the user interface homepage

## 8.2 User Groups and User Rights

One user with administrator authorization can be created on each product via the user interface. As administrator, you can add further system users in Sunny Portal. Thus, users have access to their Sunny Portal system and local access via the user interface of the product. In Sunny Portal, you can assign users to different user groups. The user groups have different rights in their Sunny Portal system. The following user groups are possible:

- Administrator
- Installer
- User

The scope of functions can be changed by means of updates and purchase of additional apps.

Rights	User group		
	Administrator	Installer	User
Displaying analysis tool*	–	–	–
Displaying system properties	✓	✓	✓
Configuring system properties*	–	–	–
Creating and configuring system groups*	–	–	–
Displaying system monitoring	✓	✓	✓
Configuring system monitoring*	–	–	–
Displaying configuration of system monitoring*	–	–	–
Displaying user rights*	–	–	–
Configuring user rights*	–	–	–
Configuring notifications*	–	–	–
Displaying notification configuration*	–	–	–
Displaying CO <sub>2</sub> widget	✓	✓	✓



Rights	User group		
	Administrator	Installer	User
Exporting data and parameters	✓	✓	–
Displaying energy balance*	–	–	–
Displaying energy balance widget*	–	–	–
Displaying energy and power	✓	✓	✓
Displaying event monitor	✓	✓	–
Displaying yield widget	✓	✓	✓
Entering device data manually (e.g. gas meter)*	–	–	–
Change device properties	✓	✓	–
Adding devices to systems	✓	✓	–
Displaying grid management service widget.	✓	✓	✓
Importing parameters	✓	✓	–
Configuring parameter values	✓	✓	–
Displaying performance ratio widget	✓	✓	✓
Activating service access	✓	✓	–
Configuring the SMA Smart Connected*	–	–	–
Displaying status widget	✓	✓	✓
Creating and configuring system sections	✓	✓	–
Displaying weather widget	✓	✓	✓

\* Function available in Sunny Portal

### 8.3 Configuring Limitation of Active Power Feed-In

With the Data Manager, you can implement grid operator specifications for the limitation of the active power feed-in from 0% to 100% in your system. The setpoint for limitation of active power feed-in is specified in percent. The total system power is taken as the reference value. If your grid operator requires the system not to feed in any active power, you must limit the active power feed-in to a fixed value of 0% and additionally adjust the preset value for the active power gradient. Thus, it is possible to limit the active power feed-in to 0% within a few seconds. To compensate for load

step changes and to establish a safety distance to the active power limitation, a negative value can be set. This achieves a timely limitation of the active power feed-in. The value for the limitation of the active power feed-in should be adjusted to the load step changes accordingly. No further inverter settings are necessary.

## NOTICE

### **Responsibility of the system operator for grid management service specifications**

The system operator is responsible for the correctness of the configurations and information on grid management services and system power. Incorrect settings and specifications can result in device and system damages.

- Set the grid management service specifications required by the grid operator and laid down in the standards correctly. Contact the grid operator if necessary.
- Enter correct values for system power. Adjust the values for system power during system expansions.
- Ensure that all required default values are applied or sent cyclically.

### **i Supported inverters for the limitation of the active power feed-in to 0%**

The limitation of the active power feed-in to 0% are only supported by inverters that support the fallback function. In the event of a communication failure between the product and the inverter, the inverter is reduced to an output power of 0% during fallback). For more information see the inverter manual at [www.SMA-Solar.com](http://www.SMA-Solar.com).

#### **Requirements:**

- The configuration for the active power limitation must be agreed upon with the responsible grid operator.
- There must be an appropriate energy meter installed at the grid-connection point within the system.

#### **Procedure:**

1. Log into the user interface of the Data Manager.
2. Select the menu item **Grid management service** in the menu **Configuration**.
3. Select the button **Configuration and activation** in the **Active power** row.
  - The installation assistant will open.
4. Confirm every step with [**Continue**]
5. Select the operating mode **Closed-loop control**.
6. Select the signal source **Manual control**.
7. Enter the value 0 in the field **Active power setpoint**:
  - To set the limitation of the active power feed-in to 0% of the total system power, for example, enter the value 0 in the **Active power setpoint** field.
  - To set the limitation of the active power feed-in to -10% of the total system power, for example, enter the value -10 in the **Active power setpoint** field.
8. Activate the switch to adjust the modification speed of the setpoint.

9. Enter the value 1 in the field **Setting time**
10. Enter the value 100 in the field **Active power gradient**.
11. Enter the total PV array power in the field **Total system power**.
12. Click on [**Save**].

## 8.4 Configuring Reactive Power as a Function of Grid Voltage

With the data manager, you can implement reactive power as a function of grid voltage ( $Q(V)$ ) into your system.

### NOTICE

#### Responsibility of the system operator for grid management service specifications

The system operator is responsible for the correctness of the configurations and information on grid management services and system power. Incorrect settings and specifications can result in device and system damages.

- Set the grid management service specifications required by the grid operator and laid down in the standards correctly. Contact the grid operator if necessary.
- Enter correct values for system power. Adjust the values for system power during system expansions.
- Ensure that all required default values are applied or sent cyclically.

#### Requirements:

- There must be an appropriate energy meter installed at the grid-connection point within the system.

#### Procedure:

1. Log into the user interface of the Data Manager.
2. Select the menu item **Grid management service** in the menu **Configuration**.
3. Select the button **Configuration and activation** in the **Reactive power** row.
  - The installation assistant will open.
4. Confirm every step with [**Continue**]
5. Select the operating mode **Closed-loop control**.
6. Select the signal source **Reactive power / voltage characteristic curve  $Q(V)$** .
7. Follow the installation assistant steps and make the settings according to the specifications required by the grid operator and laid down in the standards.
8. Click on [**Save**].
9. In case of new and replaced inverters, select the menu item **Parameter** in the menu **Configuration** and set the following parameters:
  - Country standard of inverter
  - Operating mode of the inverter feed-in management.

## 8.5 Configuring Modbus Devices

Connected Modbus devices can be used, for example, as energy meters for generation and consumption data at the grid-connection point or for energy monitoring. For this, predefined Modbus profiles, user-created Modbus profiles or the SunSpec Modbus profile must be used. The Modbus profiles will then be assigned to the Modbus devices.

### IP addresses of Modbus devices

In systems with Modbus devices, static IP addresses must be assigned to all Modbus devices. Suitable IP addresses can be assigned to the Modbus devices from the free address supply of the network segment either manually or dynamically via DHCP.

If the IP addresses are to be assigned dynamically, DHCP must be activated in the router (see the router manual). Make sure that the Modbus devices do not contain variable IP addresses but always the same IP addresses.

This also applies to data managers that are used as subordinated devices (slaves).

### Creating a New Modbus Profile

1. Log into the user interface of the Data Manager.
2. Select the menu item **Device administration** in the menu **Configuration**.
3. Select the  button.
4. Select **Modbus devices** and confirm with **[Next]**.
5. Select **Manage your own Modbus profiles**.
6. Select **Create a new Modbus profile**.
7. Fill out the entry fields and select **[Save]**.

### Registering a New Modbus Device and Assigning a Modbus Profile

#### Requirements:

- The Modbus devices must be in operation and connected to the Data Manager.

#### Procedure:

1. Log into the user interface of the Data Manager.
2. Select the menu item **Device administration** in the menu **Configuration**.
3. Select the  button.
4. Select **Modbus devices** and confirm with **[Next]**.
5. Fill out the input fields and confirm with **[Next]**.
  - Available Modbus devices in the system are searched for and displayed.
6. Select the Modbus devices to be added to the system and select **[Save]**.
- The connected Modbus device can be used as an energy meter for generation and consumption data at the point of interconnection, for energy monitoring or as sensor for wind speed, solar irradiation, and temperature.

## SunSpec Modbus Profile

The product supports the standardized SunSpec Modbus profile via the interface of the Modbus client (Modbus TCP/RTU). The connected Modbus devices must conform with the SunSpec specification (see manufacturer manual). The mandatory data of the following SunSpec models are supported:

### Common model:

- 1, 11, 12

### PV inverter:

- 101, 102, 103, 120, 121, 122, 123, 126, 127, 128, 129, 130, 131, 132, 160

### Energy meters:

- 201, 202, 203, 204, 211, 212, 213, 214

## 8.6 Configuring a System with several Data Managers

Several Data Managers can be integrated in one system. There are three options for using the Data Manager:

- Stand-alone master
- Superordinate master
- Slave

In systems with master and slaves, all slaves must first be commissioned to add them when the master is commissioned. In order to subsequently use a stand-alone master or a superordinate master as a slave, the product must be reset to the default settings.

### Stand-alone master

Select the option **Stand-alone master (recommended)** in the installation assistant if you use the Data Manager as a stand-alone device without other subordinate Data Managers for open-loop or closed-loop control of your system.

### Superordinate master

Select the option **Superordinate master** in the installation assistant if you use the Data Manager as a superordinate device without other subordinate Data Managers for open-loop or closed-loop control of your system. With this option, the superordinate Data Manager forwards the open-loop or closed-loop control commands to the subordinate Data Manager via Modbus. For this, subordinate Data Managers must be integrated as Modbus devices into the system of the superordinate Data Manager. Meters at the grid-connection point must be connected to the superordinate Data Manager.

## Slave

Select the option **Slave** in the installation assistant if you want to use the Data Manager as subordinate device. With this option, the subordinate Data Manager receives the open-loop and closed-loop control commands of a superordinate device. These commands are forwarded as open-loop control commands to the connected devices. In systems with a superordinate Data Manager as master, all slaves must first be commissioned to be able to integrate them into the system of the superordinate Data Manager. To do this, select the operating mode **Control** and the signal source **Modbus** for the subordinate Data Manager.

## 8.7 Speedwire Encryption of the System Communication

Speedwire encryption is used to encrypt system communication between all compatible Speedwire devices. In order to be able to use the Speedwire encryption in the system, all connected Speedwire devices, apart from the SMA Energy Meter, must support the SMA Speedwire Encrypted Communication function.

### **i** Speedwire encryption for systems with one Data Manager

In systems with more than one Data Manager, there can be overlaps in the system encryption.

- Only enable the Speedwire encryption in systems with one Data Manager.

#### Requirements:

- All devices in the local network must be in operation and connected to the product via an Internet router.
- All devices must support the Speedwire encryption.

#### Procedure:

1. Log into the user interface of the Data Manager.
2. Select the menu item **Device administration** in the menu **Configuration**.
3. Select the **+** button.
4. Select **SMA Speedwire devices** and confirm with [**Next**].
  - All SMA Speedwire devices in the systems are searched for and displayed.
5. Enable SMA Speedwire encryption and select [**Continue**].
6. Assign a new system password and select [**Save**].

## 8.8 Switching Digital Outputs Based on Thresholds

The digital outputs of connected I/O systems can be switched depending on measured values or states. In this way, heat pumps or relays, for example, can be controlled by specifying a defined output. A tolerance (hysteresis) dependent on the selected operator prevents the digital outputs from switching even with slight power fluctuations.

Operator	Tolerance
Greater than or equal to ( $\geq$ )	1 %
Less than or equal to ( $\leq$ )	1 %
Equal to	5 %

The following limiting values and parameters are available:

- Alarm in case of warning or error
- Alarm in case of error
- System active power
- System reactive power
- System active power at point of interconnection (grid feed-in)
- System reactive power at the point of interconnection
- Reactive power setpoint
- Setpoint of active power limitation
- System-wide state of charge of batteries (SOC)
- Active access through direct selling

**Requirements:**

- All devices in the local network must be in operation and connected to the product via an Internet router.
- All devices must support the Speedwire encryption.

**Procedure:**

1. Log into the user interface of the Data Manager.
2. Select the menu item **Grid management services** in the menu **Configuration**.
3. Select the button **To the configuration** in the **Assigning analog outputs** row.
4. To configure the digital outputs of a connected device, select the button **+**.
5. Fill out the entry fields and select [**Save**].

## 9 Firmware Update

### 9.1 Updating the Product Firmware

There are two ways to update the product firmware:

- Enabling Automatic Firmware Update (recommended)
- Updating the Firmware at the product via USB Flash Drive

#### Enabling Automatic Firmware Update (recommended)

- Activating the automatic firmware update via the user interface during commissioning. By activating the automatic firmware update, the product searches and installs new firmware versions automatically provided an Internet connection exists. In the process, an available firmware update may take up to 24 hours since the product only searches once in 24 hours for a firmware update.
- Subsequently, the automatic firmware update can be enabled in the device parameters of the product. To do this, select the menu item **Parameters** in the **Configuration** menu and for the parameter **Automatic updates turned on** select the value **Yes**.

#### Updating the Firmware at the product via USB Flash Drive

##### Requirements:

- A USB flash drive with maximum 32 GB storage capacity and file system FAT32 must be available.
- USB flash drive at least in the version 2.0
- The product must be commissioned.

##### Procedure:

1. Create an **update** folder on the USB flash drive.
2. Save the update file with the desired firmware in the **update** folder on the USB flash drive. The update file is only available from the Service (see Section 14, page 56).
3. Rename update file **update.upd**.
4. Plug the USB flash drive into the USB port on the product.
  - During the firmware update, the System LED flashes orange and the COM LED flashes green. This process can take several minutes.
  - Once the new firmware update has been successfully downloaded, the System LED lights up green and the COM LED flashes green. This process can take several seconds.
  - The product restarts automatically. During the restart, the System LED and the COM LED flash orange. The start-up procedure can take up to five minutes.
  - Once the firmware has been updated successfully, the System LED glows green continuously and the COM LED flashes green. If the System LED does not glow green permanently and the COM LED does not flash green, update the firmware again.
5. Once the firmware has been successfully updated, pull the USB flash drive out of the USB port on the product.



## 9.2 Updating the Firmware of Connected SMA Products

There are two ways to update the firmware of connected SMA products:

- Enabling Automatic Firmware Update (recommended)
- Updating the firmware at the Data Manager via USB flash drive

### Enabling Automatic Firmware Update (recommended)

- Activating the automatic firmware update via the user interface during commissioning. By activating the automatic firmware update, the Data Manager searches and installs new firmware versions of connected SMA products automatically provided an Internet connection exists. In the process, an available firmware update may take up to 24 hours since the Data Manager only searches once in 24 hours for a firmware update.
- Subsequently, the automatic firmware update can be enabled in the device parameters of the product. To do this, select the menu item **Parameters** in the **Configuration** menu and for the parameter **Device updates turned on** select the value **Yes**.

### Updating the firmware at the Data Manager via USB flash drive

#### Firmware updates despite disabled automatic firmware update

The firmware update of the USB flash drive is installed on connected SMA products even if the automatic firmware update function is disabled in the parameters.

- Only insert the USB flash drive with firmware updates into the USB port if firmware updates are to be installed.

#### Requirements:

- A USB flash drive with maximum 32 GB storage capacity and file system FAT32 must be available.
- USB flash drive at least in the version 2.0
- The Data Manager must be in operation.
- The Data Manager must be connected to the connected SMA products via the local network.
- The connected SMA products must be in operation.

#### Procedure:

1. Create an **update** folder on the USB flash drive.
2. Download the desired update file with the file ending **\*.up2** at [www.SMA-Solar.com](http://www.SMA-Solar.com).
3. Save the update file in the **update** folder on the USB flash drive.
4. Plug the USB flash drive into the Data Manager USB port.
  - The System LED flashes orange while the update file is being checked.
  - The firmware of the connected SMA products will be updated. Depending on the SMA product and the transmission quality, this process can take several hours.
5. In the **Event monitor** menu on the Data Manager user interface, check whether the firmware has been updated successfully.
6. Once the firmware has been successfully updated, pull the USB flash drive out of the Data Manager USB port.

# 10 Troubleshooting

Problem	Cause and corrective measures
<p>Obsolete or incorrect measured values are displayed.</p>	<p><b>Connection to VPN or Internet is disrupted.</b></p> <ul style="list-style-type: none"> <li>• Ensure that the network cable is connected correctly and that the network port Link LED is glowing.</li> </ul> <p>or</p> <ul style="list-style-type: none"> <li>• Check the status of the connected devices in the device overview in Sunny Portal.</li> </ul> <hr/> <p><b>The energy meter is connected incorrectly.</b></p> <ul style="list-style-type: none"> <li>• Connect the energy meter correctly (see energy meter manual).</li> </ul> <p>or</p> <ul style="list-style-type: none"> <li>• Swap the channels for purchased-electricity and feed-in meters in the meter configuration on the user interface.</li> </ul> <p>or</p> <ul style="list-style-type: none"> <li>• In the meter configuration on the user interface select an <b>inverse</b> profile.</li> </ul> <hr/> <p><b>The display in your web browser is not updated.</b></p> <ul style="list-style-type: none"> <li>• Reload the page in your web browser.</li> </ul>
<p>Not all devices are being detected.</p>	<p><b>Not all devices are in operation.</b></p> <ul style="list-style-type: none"> <li>• Ensure that all devices are in operation.</li> </ul> <hr/> <p><b>There are too many devices in the system.</b></p> <ul style="list-style-type: none"> <li>• Ensure that no more than permissible devices are in the system.</li> </ul> <hr/> <p><b>The network configuration of the local network is incorrect.</b></p> <ul style="list-style-type: none"> <li>• Ensure that the network configuration is correct. SMA Solar Technology AG recommends automatic network configuration.</li> </ul>
<p>The Data Manager user interface cannot be called up.</p>	<p><b>The firmware has been updated to a newer version.</b></p> <ul style="list-style-type: none"> <li>• After a firmware update, errors may arise when restarting the products. Reset the product to the default settings. To do so, press and hold down the function button for 15 to 20 seconds. This will also reset all of the data in the product.</li> </ul>
<p>Modified parameters will not be adopted after a waiting time of approximately one minute.</p>	<p><b>Parameters are modified by two users at the same time.</b></p> <ul style="list-style-type: none"> <li>• Ensure that parameters cannot be modified at the same time on the user interface of the product and in Sunny Portal.</li> </ul>
<p>The Data Manager cannot be registered in Sunny Portal.</p>	<p><b>The Internet connection via a proxy server is not possible.</b></p> <ul style="list-style-type: none"> <li>• Contact your network administrator.</li> </ul> <hr/> <p><b>The PIC or RID entry is incorrect.</b></p> <ul style="list-style-type: none"> <li>• Verify your entry.</li> </ul>

Problem	Cause and corrective measures
<p>The firmware of a connected SMA product was not updated during a firmware update via USB flash drive.</p>	<p><b>The firmware version downloaded is not the latest or is not suitable for the SMA product.</b></p> <ul style="list-style-type: none"> <li>The firmware version must be later than the firmware version installed on the SMA product. Ensure that you have downloaded the correct firmware version for your SMA product and update the firmware again.</li> </ul> <hr/> <p><b>The DC input voltage is not sufficient for a firmware update.</b></p> <ul style="list-style-type: none"> <li>With older inverters, a firmware update is only possible above a certain DC input voltage. Depending on the time of day, the weather, and the condition of the PV modules (e.g. affected by pollution or covered with snow), the DC input voltage may be too low for a firmware update. Ensure that there is sufficient DC voltage present and update the firmware again.</li> </ul> <hr/> <p><b>The transmission quality in the local network is not sufficient.</b></p> <ul style="list-style-type: none"> <li>Errors can occur during data transmission if the transmission quality in the local network is too low. Check the network status of your local network and, if necessary, contact your network administrator.</li> </ul>
<p>No data are displayed on the user interface of the Data Manager.</p>	<p><b>The buffer capacitor of the Data Manager's real-time clock might have discharged due to being without voltage supply for a longer time period.</b></p> <ul style="list-style-type: none"> <li>Make sure that the Data Manager has access to a time server on the Internet or in the local network to obtain a current time.</li> </ul>

# 11 Decommissioning the Product

## ⚠ WARNING

### Danger to life due to electric shock

Lethal voltages are present at the connection point of the utility grid.

- Disconnect the connection point from the utility grid using the separator (e.g. circuit breaker).

1. Pull the two-pole power supply unit plug out of the jack **X1** on the Data Manager.
2. Release the RJ45 network cable plug and pull out of the network port **X4** or **X5** on the Data Manager.
3. Pull the six-pole power supply unit plug out of the jack **X3** on the Data Manager.
4. Disassembling the Data Manager
  - If mounted on a top-hat rail, detach the Data Manager from the top-hat rail. Tilt the lower edge of the Data Manager forwards and lift it up and off the top-hat rail.

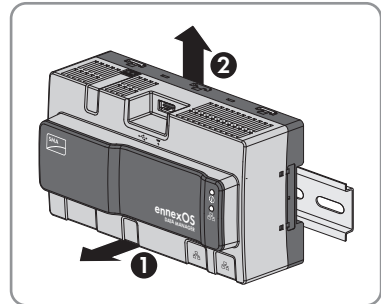

- If mounted on a wall, remove the screws from the brackets and remove the Data Manager.
5. If the Data Manager is to be disposed of, dispose of the Data Manager in accordance with the locally applicable disposal regulations for electronic waste.

## 12 Technical Data

### Communication

SMA devices	Max. 50 devices, Speedwire, 100 Mbit/s
I/O systems and meters	Ethernet, 10/100 Mbit/s, Modbus TCP
RS485 devices	Modbus RTU / 1200 baud, 9600 baud or 19200 baud

### Connections

Voltage supply	2-pole connection, MINI COMBICON
Network (LAN)	2 x RJ45 switched, 10BaseT / 100BaseT
USB	1 x USB 2.0, type A

### Voltage supply

Voltage supply	External power supply unit (available as an accessory)
Input voltage range	10 V to 30 V DC
Power consumption	Typically 4 W

### Ambient Conditions in Operation

Ambient and storage temperature	-20°C to +60°C (-4°F to +140°F)
Max. permissible value for relative humidity (non-condensing)	5% to 95%
Maximum operating altitude above mean sea level (MSL)	0 m to 3000 m (≥70 kPa)
Degree of protection	IP20 (NEMA 1)

### General Data

Dimensions (W x H x D)	161.1 mm x 89.7 mm x 67.2 mm (6.3 in x 3.5 in x 2.7 in)
Weight	220 g (0.49 lb)
Mounting location	Indoors
Mounting type	Top-hat rail mounting / wall mounting
Status display	LEDs for system and communication status

### Digital inputs

Quantity	5
----------	---

Input voltage	24 V DC
Maximum cable length	30 m (98 ft)

**Equipment**

Warranty	2 years
Certificates and approvals	<a href="http://www.SMA-Solar.com">www.SMA-Solar.com</a>

## 13 Accessories

You will find the accessories for your product in the following overview. If required, these can be ordered from SMA Solar Technology AG or your distributor.

Designation	Brief description	SMA order number
Top-hat rail power supply unit*	DIN rail power supply unit for SMA Data Manager M	CLCON-PWRSUPPLY
ioLogik E1241	I/O system by Moxa Europe GmbH (4AO)	eIO-E1241
ioLogik E1242	I/O system by Moxa Europe GmbH (4AI/4DI/4DIO)	eIO-E1242
ioLogik E1260	I/O system by Moxa Europe GmbH (6RTD)	eIO-E1260
WAGO-I/O-SYSTEM 750	I/O system by WAGO Kontakttechnik GmbH & Co. KG (2ETH, 1RS232/485)	115214-00.01

\* Not permitted in all countries (e.g., Japan). For information on whether an accessory is permitted in your country, visit the website of your country's SMA subsidiary company at [www.SMA-Solar.com](http://www.SMA-Solar.com) or contact your distributor.

## 14 Contact

If you have technical problems with our products, please contact the SMA Service Line. The following data is required in order to provide you with the necessary assistance:

- Device type
- Serial number
- Firmware version
- Event message

Deutschland	SMA Solar Technology AG	Belgien	SMA Benelux BVBA/SPRL
Österreich	Niestetal	Belgique	Mechelen
Schweiz	Sunny Boy, Sunny Mini Central, Sunny Tripower, Sunny High- power: +49 561 9522-1499 Monitoring Systems, SMA EV Charger: +49 561 9522-2499 Hybrid Controller: +49 561 9522-3199 Sunny Island, Sunny Boy Stor- age, Sunny Backup: +49 561 9522-399 Sunny Central, Sunny Cen- tral Storage: +49 561 9522-299 SMA Online Service Center: www.SMA-Service.com	België	+32 15 286 730 for Netherlands: +31 30 2492 000
		Luxemburg	SMA Online Service Center: www.SMA-Service.com
		Luxembourg	
		Nederland	
		Česko	SMA Service Partner TERMS a.s +420 387 6 85 111
		Magyarország	SMA Online Service Center: www.SMA-Service.com
		Slovensko	
		Türkiye	SMA Service Partner DEKOM Telekomünikasyon A. Ş +90 24 22430605 SMA Online Service Center: www.SMA-Service.com
France	SMA France S.A.S. Lyon +33 472 22 97 00 SMA Online Service Center: www.SMA-Service.com	Ελλάδα	SMA Service Partner AKTOR FM. Αθήνα +30 210 8184550 SMA Online Service Center: www.SMA-Service.com
		Κύπρος	
España	SMA Ibérica Tecnología Solar, S.L.U. Barcelona +34 935 63 50 99 SMA Online Service Center: www.SMA-Service.com	United King- dom	SMA Solar UK Ltd. Milton Keynes +44 1908 304899 SMA Online Service Center: www.SMA-Service.com
Portugal			



Italia	SMA Italia S.r.l. Milano +39 02 8934-7299 SMA Online Service Center: www.SMA-Service.com	Australia	SMA Australia Pty Ltd. Sydney Toll free for Australia: 1800 SMA AUS (1800 762 287) International: +61 2 9491 4200
United Arab Emirates	SMA Middle East LLC Abu Dhabi +971 2234 6177 SMA Online Service Center: www.SMA-Service.com	India	SMA Solar India Pvt. Ltd. Mumbai +91 22 61713888
ไทย	Service Partner for String inverter: Solar Power Engineering Co., Ltd. 333/7,8,9 United Tower Building 4th floor. Soi Sukhumvit 55 (Thonglor 17), Klongton Nua, Wattana, 10110 Bangkok, Thailand +66 20598220 smaservice@spe.co.th Service Partner for Utility: Tirathai E & S Co., Ltd 516/1 Moo 4, Bangpoo Industrial Estate Sukhumvit Road, T. Praksa, A. Muang 10280 Samutprakarn, Thailand +63 1799866 servicepartner.sma@tirathai.co.th	대한민국	Enerone Technology Co., Ltd 4th Fl, Jungbu Bldg, 329, Yeongdong-daero, Gangnam-gu, Seoul, 06188, Korea +82-2-520-2666
		Argentina	SMA South America SPA
		Brasil	Santiago de Chile
		Chile	+562 2820 2101
		Perú	
		South Africa	SMA Solar Technology South Africa Pty Ltd. Cape Town 08600SUNNY (08600 78669) International: +27 (0)21 826 0699 SMA Online Service Center: www.SMA-Service.com
Other countries	International SMA Service Line Niestetal 00800 SMA SERVICE (00800 762 7378423) SMA Online Service Center: www.SMA-Service.com		

United States	SMA Solar Technology America LLC Rocklin, CA	Toll free for USA and US Territories +1 877-MY-SMATech (+1 877-697-6283) International: +1 916 625-0870
Canada	SMA Solar Technology Canada Inc. Mississauga	Toll free for Canada / Sans frais pour le Canada : +1 877-MY-SMATech (+1 877-697-6283)
México	SMA Solar Technology de México Mexico City	Internacional: +1 916 625-0870

## 15 EU Declaration of Conformity

within the scope of the EU directives

- Electromagnetic compatibility 2014/30/EU (29.3.2014 L 96/79-106) (EMC)
- Low Voltage Directive 2014/35/EU (29.3.2014 L 96/357-374) (LVD)
- Radio Equipment Directive 2014/53/EU (22.5.2014 L 153/62) (RED)
- Restriction of the use of certain hazardous substances 2011/65/EU (L 174/88, June 8, 2011) and 2015/863/EU (L 137/10, March 31, 2015) (RoHS)



SMA Solar Technology AG confirms herewith that the products described in this document are in compliance with the fundamental requirements and other relevant provisions of the above-mentioned directives. The entire EU Declaration of Conformity can be found at [www.SMA-Solar.com](http://www.SMA-Solar.com).

## 16 Compliance Information

### FCC Compliance

This device complies with Part 15 of the FCC Rules and with Industry Canada licence-exempt RSS standard(s).

Operation is subject to the following two conditions:

1. this device may not cause harmful interference, and
2. this device must accept any interference received, including interference that may cause undesired operation.

Le présent appareil est conforme aux CNR d'Industrie Canada applicables aux appareils radio exempts de licence.

L'exploitation est autorisée aux deux conditions suivantes :

1. l'appareil ne doit pas produire de brouillage, et
2. l'utilisateur de l'appareil doit accepter tout brouillage radioélectrique subi, même si le brouillage est susceptible d'en compromettre le fonctionnement.

NOTE: This equipment has been tested and found to comply with the limits for a Class B digital device, pursuant to Part 15 of the FCC Rules. These limits are designed to provide reasonable protection against harmful interference in a residential installation. This equipment generates, uses and can radiate radio frequency energy and, if not installed and used in accordance with the instructions, may cause harmful interference to radio communications. However, there is no guarantee that interference will not occur in a particular installation. If this equipment does cause harmful interference to radio or television reception, which can be determined by turning the equipment off and on, the user is encouraged to try to correct the interference by one or more of the following measures:

- Reorient or relocate the receiving antenna.
- Increase the separation between the equipment and receiver.
- Connect the equipment into an outlet on a circuit different from that to which the receiver is connected.
- Consult the dealer or an experienced radio/TV technician for help.

Changes or modifications made to this equipment not expressly approved by SMA Solar Technology AG may void the FCC authorization to operate this equipment.

### RF Exposure Statement

Radiofrequency Radiation Exposure Information:

This equipment complies with FCC radiation limits set forth for an uncontrolled environment. This equipment should be installed and operated with minimum distance of 20 cm (8 in) between the radiator and your body.

### IC Compliance

This Class B digital apparatus complies with Canadian ICES-003.

Cet appareil numérique de la classe B est conforme à la norme NMB-003 du Canada.



